

The British University in Egypt

BUE Scholar

Architectural Engineering

Engineering

2020

Energy-Scape Web-Based Application is an Effective Tool to Overcome the Basic Knowledge of Architects Toward Renewable Energy Properties

Rania Rushdy Moussa

The British University in Egypt, rania.rushdy@bue.edu.eg

Khaled M. Dewidar

The British University in Egypt, Khaled.dewidar@bue.edu.eg

Follow this and additional works at: https://buescholar.bue.edu.eg/arch_eng



Part of the [Architecture Commons](#), and the [Engineering Commons](#)

Recommended Citation

Moussa, Rania Rushdy and Dewidar, Khaled M., "Energy-Scape Web-Based Application is an Effective Tool to Overcome the Basic Knowledge of Architects Toward Renewable Energy Properties" (2020).

Architectural Engineering. 10.

https://buescholar.bue.edu.eg/arch_eng/10

This Article is brought to you for free and open access by the Engineering at BUE Scholar. It has been accepted for inclusion in Architectural Engineering by an authorized administrator of BUE Scholar. For more information, please contact bue.scholar@gmail.com.

Energy-Scape Web-Based Application is an Effective Tool to Overcome the Basic Knowledge of Architects Toward Renewable Energy Properties

<https://doi.org/10.3991/ijet.v15i10.13669>

Rania Ruhdy Moussa ^(✉), Khaled Mohamed Dewidar
The British University in Egypt, Cairo, Egypt
Rania.Rushdy@bue.edu.eg

Abstract—In last few years, research on renewables were shifted from integrating renewable energy (RE) with buildings into integrating renewable energy (RE) within urban environment due to the large occupies of urban areas in comparing to the building foot print. Urban areas such as urban landscape areas have a great potential in generating huge amount of energy that could satisfy the needs of urban neighborhoods. The presented research identify the properties of a new elements called Energy-scape elements (ESE) that integrates RE devices with urban landscape elements. This research focuses on analyzing the efficiency of web-based application called “Energy-scape software” (ESS) and compare its efficiency with Energy-scape database (ESD) through a qualitative method. The research concludes that Energy-scape software (ESS) application is an effective tool for implementing Energy-scape elements (ESE) and it overcome the basic knowledge of architects and landscape designers toward renewable properties. Moreover, it identifies the optimum type and location of Energy-scape elements (ESE) within a specific project, and it calculates the impact of using Energy-scape elements (ESE) in term of energy-savings.

Keywords—Sustainable City, Energy-scape Elements (ESE), Energy-scape software (ESS), Energy-scape database (ESD), Landscape elements, Renewable Energy.

1 Introduction

Creating sustainable city was the scope of researchers in the past few decades. Yet sustainable architecture practices in Egypt does not shows constant steps of growth [1]. The main intention of this research is to help in spreading the sustainable practice in Egypt by presenting a digital tool that integrates renewable energy within the urban environment. This research presents and evaluate the efficiency of new online application called “Energy-scape software”. Before introducing the software, the research will first introduce Energy-scape elements (ESE). ESE is a sustainable landscape elements that share the properties of RE devices in generating clean and efficient energy, without compensating the functional and aesthetic properties of landscape elements and [2] & [3].

Energy-scape elements (ESE) integrates landscape elements with RE devices. As stated in Ref. [4], landscape elements can be classified into 5 categories as shown in figure (1).

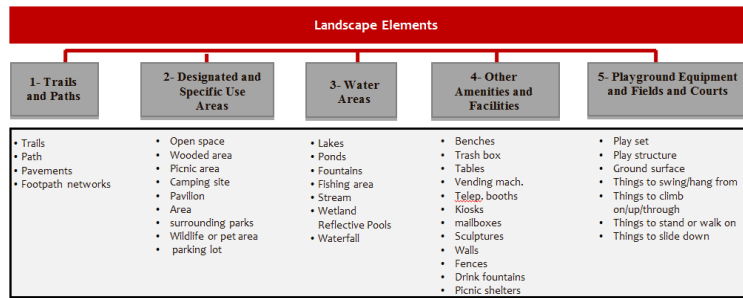

Fig. 1. Framework of landscape elements [3]

While Renewable energy (RE) sources, are classified into biomass energy, geothermal energy, hydroelectric power, piezoelectric cells, solar energy (PV, and CSP) and wind energy [3, 5, 6, 7, 8, 9, 10, 11, 13 & 14].

In this research, a digital tool called ‘Energy-scape software’ will be examine. This web-based application intends to assist the architects and landscape designers to overcome their basic knowledge toward renewables and to know the properties of ESE. The software should assist landscape designers in designing ESE and choosing the most suitable elements for their designs. ESS entitled to encourage the architects and landscape designers in using energy generating landscape elements known as ESE instead of aesthetic landscape elements. On the other hand, ESE will preserve the aesthetic view of landscape elements and generates clean energy. The database used to design ESS is presented in table [1].

Table 1. The elements and properties of ESE [2 & 3]

Landscape Elements		Renewable energy					
1- Trails & Paths	Trails	PZ (Pavement)	\$2,397	10 m2	2 kWh	\$20	15 years
		PZ (Roads)	\$7,397	10 m	16 kWh	\$20	15 years
		P.V	\$2,148.66	2 m2	3.6 kWh	\$85	25 years
		Small Wind Turbines	\$3,660	12 m2	4.5 kWh	\$20	20 years
	Path	Geothermal	\$1,780,313	1.5 m2	24 kWh	\$50	25 years
		PZ (Pavement)	\$2,397	10 m2	2 kWh	\$20	15 years
		PZ (Roads)	\$7,397	10 m	16 kWh	\$20	15 years
		P.V	\$1,762	2 m2	3.6 kWh	\$85	25 years
	Pavements	Small Wind Turbines	\$1,340	12 m2	4.5 kWh	\$20	20 years
		Geothermal	\$1,780,023	1.5 m2	24 kWh	\$50	25 years
		PZ (Pavement)	\$2,397	10 m2	2 kWh	\$20	15 years
		PZ (Roads)	\$7,397	10 m	16 kWh	\$20	15 years
		P.V	\$1,742	2 m2	3.6 kWh	\$85	25 years

	Footpath networks	Small Wind Turbines	\$1,220	12 m2	4.5 kWh	\$20	20 years	
		Geothermal	\$1,780,008	1.5 m2	24 kWh	\$50	25 years	
		PZ (Pavement)	\$2,397	10 m2	2 kWh	\$20	15 years	
		PZ (Roads)	\$7,397	10 m	16 kWh	\$20	15 years	
		P.V	\$1,782	2 m2	3.6 kWh	\$85	25 years	
		Small Wind Turbines	\$1,460	12 m2	4.5 kWh	\$20	20 years	
2- Designated & Specific Use Areas	Open space	Geothermal	\$1,780,038	1.5 m2	24 kWh	\$50	25 years	
		PZ (Pavement)	\$2,447	10 m2	2 kWh	\$20	15 years	
		P.V	\$1,742	2 m2	3.6 kWh	\$85	25 years	
		Biomass	\$90,421.50	2.5m3	510 kWh	\$40	26 years	
		Small Wind Turbines	\$1,220	12 m2	4.5 kWh	\$20	20 years	
	Wooded area	Geothermal	\$1,780,008	1.5 m2	24 kWh	\$50	25 years	
		P.V	\$1,792	2 m2	3.6 kWh	\$85	25 years	
		Biomass	\$90,484.0	2.5m3	510 kWh	\$40	26 years	
	Picnic area	Geothermal	\$1,780,045	1.5 m2	24 kWh	\$50	25 years	
		P.V	\$1,742	2 m2	3.6 kWh	\$85	25 years	
		Biomass	\$90,421.50	2.5m3	510 kWh	\$40	26 years	
		Small Wind Turbines	\$1,220	12 m2	4.5 kWh	\$20	20 years	
	Camping site	Geothermal	\$1,780,008	1.5 m2	24 kWh	\$50	25 years	
		Biomass	\$90,421.50	2.5m3	510 kWh	\$40	26 years	
		Small Wind Turbines	\$1,220	12 m2	4.5 kWh	\$20	20 years	
	Area surrounding park	Geothermal	\$1,780,008	1.5 m2	24 kWh	\$50	25 years	
		P.V	\$1,742	2 m2	3.6 kWh	\$85	25 years	
		Biomass	\$90,421.50	2.5m3	510 kWh	\$40	26 years	
		Small Wind Turbines	\$1,220	12 m2	4.5 kWh	\$20	20 years	
	Wildlife or pet area	Geothermal	\$1,780,008	1.5 m2	24 kWh	\$50	25 years	
		Biomass	\$90,421.50	2.5m3	510 kWh	\$40	26 years	
	Parking lot	Geothermal	\$1,780,008	1.5 m2	24 kWh	\$50	25 years	
		PZ (Roads)	\$7,397	10 m	16 kWh	\$20	15 years	
		P.V	\$2,148.66	2m2	3.6 kWh	\$85	25 years	
		Biomass	\$97,909.0	2.5m3	510 kWh	\$40	26 years	
		Small Wind Turbines	\$3,660	12 m2	4.5 kWh	\$20	20 years	
	3- Water Areas	Lakes	Hydroelectric	\$1,897	φ1.1m	25 kWh	\$50	50 years
		Ponds	Hydroelectric	\$1,897	φ1.1m	25 kWh	\$50	50 years
Fishing area		Hydroelectric	\$1,897	φ1.1m	25 kWh	\$50	50 years	
Stream		Hydroelectric	\$1,897	φ1.1m	25 kWh	\$50	50 years	
Wetland		Hydroelectric	\$1,897	φ1.1m	25 kWh	\$50	50 years	
Reflective pools		P.V	\$2,152	2 m2	3.6 kWh	\$85	25 years	
Waterfall		Hydroelectric	\$1,897	φ1.1m	25 kWh	\$50	50 years	
Trash box		P.V	\$866.0	1 m2	1.8 kWh	\$85	25 years	
4- Other Amenities & Facilities	Telep. booths	PZ (Pavement)	\$460	1.5 m2	0.3 kWh	\$20	15 years	
		P.V	\$1,410	1.5 m2	2.7 kWh	\$85	25 years	
	Kiosks	P.V	\$2,332	2 m2	3.6 kWh	\$85	25 years	
		Small Wind Turbines	\$396.7	φ1m	0.375kWh	\$20	20 years	
	mailboxes	P.V	\$97	0.0931 m2	0.168kWh	\$5	25 years	
	Drink fountains	PZ (Pavement)	\$221	0.3 m2	0.06 kWh	\$20	15 years	
		P.V	\$408	0.3 m2	0.54 kWh	\$85	25 years	
	Picnic shelters	Biomass	\$90,509	2.5 m2	510 kWh	\$40	26 years	
	5. Playground Equip-	Play set	P.V	\$1,882	2 m2	3.6 kWh	\$85	25 years

ment & Fields & Courts	Play structure	P.V	\$17,592	28 m2	50.4 kWh	\$85	25 years
	Ground surface	Biomass	\$90,421.50	2.5m3	510 kWh	\$40	26 years
		Small Wind Turbines	\$1,220	12 m2	4.5 kWh	\$20	20 years
		Geothermal	\$1,780,008	1.5 m2	24 kWh	\$50	25 years
	Things to swing/hang from	P.V	\$7,182	12 m2	21.6 kWh	\$85	25 years
		Small Wind Turbines	\$2,360	12 m2	4.5 kWh	\$20	20 years
	Things to climb on/up/through	P.V	\$21,344.50	42.5 m2	76.5 kWh	\$85	25 years
		Small Wind Turbines	\$3,560	42.5 m2	4.5 kWh	\$20	20 years
	Things to stand or walk on	PZ. C (Pavement)	\$2,347	5 m2	1 kWh	\$20	15 years
	Things to slide down	P.V	\$1,832	2 m2	3.6 kWh	\$85	25 years

The work flow of ESS is divided into three phases as shown figure (2); phase one data input, were the users are asked to enter the coordinates of the project land and to answer questions related to the geographical location of the land. Phase two process, where the software will start to filter ESE according to the answers of the geographical location and present the elements that could be used in this project or in the presented land. Phase three is data output, were the software presents the properties of the chosen ESE and suggest a location for each element in the designed land. The software can be access through http://energyscape.bue.edu.eg/web/app_dev.php.

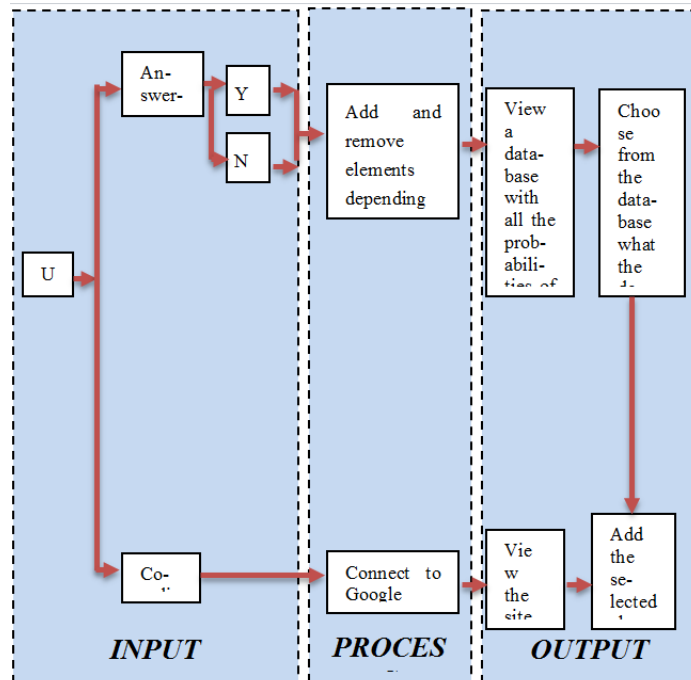

Fig. 2. Work flow of ESS [12]

The presented software were built by Programming language Hypertext Pre-processor (PHP), MySQL (My [Structured Query Language](#)) used the database presented in table (1). According to the answers provided by the user in the input phase, the software filters the components stored in the SQL database, and gives the user a filtered list of the component that is needed. In addition, the software provides the users with information about each and every component, such as the landscape properties, R.E properties (Energy/Day), total cost, and maintenance cost per year. The filtration process is mainly done by statements and conditions that the system has to go over, to carry out the final output. From that short list, the user could choose the preferable elements s/he would like to use, then the software calculates the total cost of the chosen elements, and the total amount of energy produced from using the chosen elements. Finally, the system shows the elements chosen by the user as well as it presents its properties. Moreover, the software presents the best location for each element could be placed, on the map, based on each elements properties.

2 Method

This research intends to help in creating sustainable city by increasing the percentage of energy generation from renewable energy. In order to reach the previous goal, the research examine the efficiency of online digital application that integrates renewable energy with landscape elements called Energy-scape software. The research applied experimental method for investigating the efficiency of ESE. The method took place in to three stages. Stage One: the research applied a qualitative survey, where the research asked the participants to design ESE using ESD in a public park. Moreover, the participants were asked to calculate the properties of the chosen elements. Knowing that the participants should use the min number of ESE that can generate the energy needed for the park to operate efficiently.

Stage two; the same participants were asked to design ESE in the same park using ESS as a designing tool. In stage three; the participants were given a questioner to measure their experience in designing ESE before and after using the web-based application.

2.1 Study area

The purpose of this research is to measure the efficiency of ESE using the opinions of the professional's architects and landscape designers through designing ESE. The survey took place in Egyptian private universities such as the "British university in Egypt" (BUE) and "Arab Academy for Science, Technology and Maritime Transport College of Engineering and Technology" (AASTMT).

2.2 Characteristics of participants and data collection

The participants were chosen according to their level of experience, the participant were professors, Associate professors, lecturers and teaching assistants of architecture

department. The research participants exposed to two test, after that they were given a questionnaire to summarize their experience. The participants who didn't participate in one of the three stages were eliminated from the experiments and their results were exclude from the survey. 56 architects and landscape designers were willing to participate in the research. The sample started with more than 78 participants but the participants that completed the three stages were 56 out of 78. This experiment was made during February 2018. The distribution of the participants, social and demographic characteristics are presented in table (2).

Table 2. Social and Demographic characteristics of the research participants

GENDER		AGE		EDUCATION	
Type	%	Range	%	Education level	%
Male	42%	20-29	35%	PHD degree	44%
		30-40	32%	Master degree	26%
Female	58%	Above 40	33%	BSC of engineering	30%

The aim of this research is to measure the efficiency of proposed web-based application and compare it with database that presents ESE and its properties. Questionnaires were chosen to be the method of data collection because the study measures the experience of architects and landscape designers toward the proposed web-based application. The web-based application was designed to overcome the basic knowledge of architects and landscape designers toward renewables properties and to encourage the architects and landscape designers to design ESE.

A short questionnaire consists of 14 questions have been used in this research, the 14 questions were divided into 7 questions related to ESS while the other 7 questions targeting ESD. The questions were measuring the speed of design (time saving), feasibility, the ability to modify the properties of chosen elements, software interface, and efficiency. The participants were asked to indicate the rate of effectiveness of ESS from 'totally disagree' (5 points) to 'totally agree' (1 point). Finally, questions were randomly ordered in the questionnaire to elicit more objective answers from the respondents.

2.3 Procedures

The research procedures started by choosing the participants carefully according to on their educational level. The chosen participants were asked to design ESE in a specific public park and present the properties of the chosen elements. The participants were asked to choose the most suitable elements to their sites, moreover to calculate the initial cost of all ESE used in their project and to calculate the energy generate from ESE. The goal was to pay as less money as possible to generate enough energy for this park to operate efficiently.

In stage one: the participants were asked to design ESE in a local park using ESD as a guiding tool. Since that the initial cost of RE is very high and ESE generate ener-

gy from RE that makes the initial cost of ESE high. The challenge that faced the participants was to choose the most suitable ESE according to power generation and cost.

In stage two: the participants were asked to design ESE using ESS. The participants were asked to choose elements that generate enough energy to operate the park efficiently and to pay as less money as possible.

In stage three: The participants were given a questionnaire consist of 14 questions in order to measure the rate of simplicity, time saving, and efficiency of ESS. The interviewing process was very simple because the participants were educated and had a scientific background.

The experiment took place at the “British university in Egypt” (BUE) and “Arab Academy for Science, Technology and Maritime Transport college of Engineering and Technology” (AASTMT). All the questions were described to the participants.

3 Results

This section introduces the results of the three stages. The purpose of this survey is to measure the applicability of designing landscape elements that is integrated with RE devices by professional architects and landscape designers with a poor background regarding the use and properties of renewables using ESS.

According to the questionnaire which was targeting professors, lecturers and TAs at Egyptian universities, the research revealed that 38% of the participants has a moderate background on different renewable system properties and use, while only 17% have strong background regarding the properties of renewables. Moreover, 45% which is almost half the research sample as shown in figure (3), which was collected from universities staff members have weak or no experience regarding the use of renewables as shown in figure (3). Which is consistent with the fact that Egypt has only 3 certificate sustainable buildings.

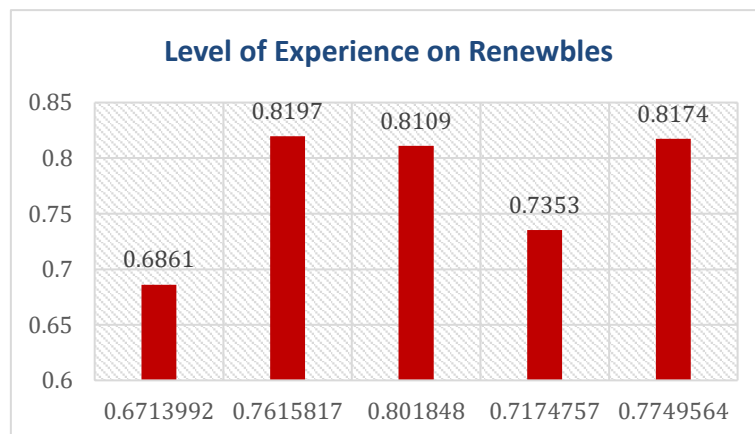

Fig. 3. The experience of professional architects and landscape designers toward the use of renewables

The results of stage one revealed that almost 32% of the participants choose ESE according to its order in the database. While, 23% of the participants choose elements with low initial cost. Although, 31% choose ESE randomly and 14% choose ESE according to the elements that is integrated with landscape the elements that is already existed in the study area as shown in figure (4). On the other hand, It was noticed that the participants needed 1 hour and 35 minute to complete the test (the first participant submit the test after 45 min and the last participant submitted the test after 95 min.).

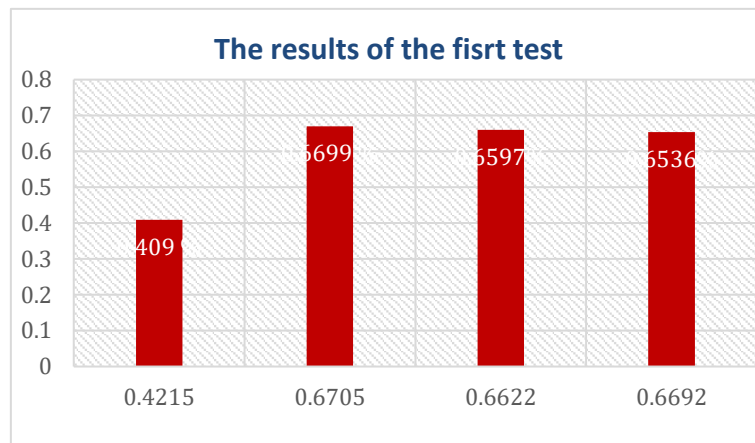

Fig. 4. The criteria that were used by the participants in stage 1

In stage two 99% of the participants chose ESE according to the elements with low initial cost and high energy production as it was presented by ESS. The participants compared the properties (cost and price) of ESE that was revealed to them by ESE. The participants chose one or two elements will low initial cost and high energy production, they stated the amount of energy needed and left the software calculate the area, cost, annual maintenance and lifetime. Finally, the participants allocate the elements according to the suggestion that was given to them by ESS It was noticed that the participants completed the test in 20 min.

Stage three, the participants were given a questionnaire that summarizing their experience in the previous two tests. The questionnaire revealed the experience of the participants toward using ESS and ESD as a designing tools for designing ESE. Some aspects where taken into consideration in the questionnaire process; these aspects are the “Simplicity, Accuracy, Time Saving, Efficiency, Design Modification and Elements Location”.

In order to understand the significant of ESS it was decided to choose the aspect that was presented previously as a measuring criteria for the efficiency of ESS. When the participants state 2 or less than 2 in any aspect, it represents the highest satisfaction aspects that satisfy the participants. The total number of response is 5 and 3 is the moderate effect, while 4 or more than 4 is the lowest satisfaction aspects that satisfy the participants.

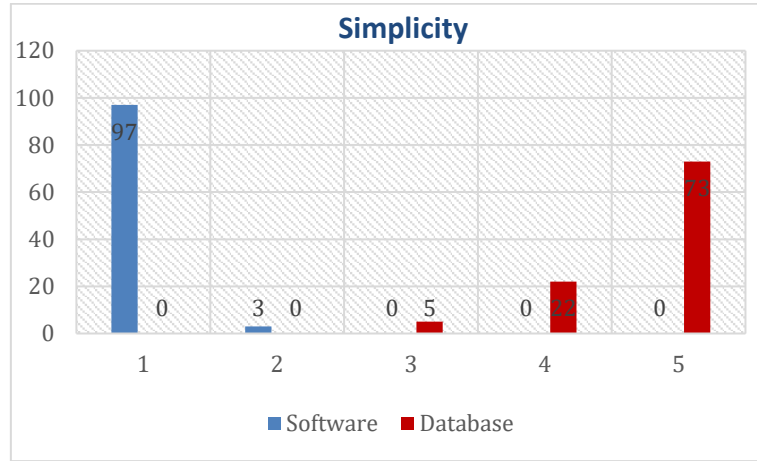

Fig. 5. A comparison between the simplicity of ESS and ESD

Figure (5) represent the simplicity, is the level of simplicity that the participant fund in using the designing tools (software or database) to design ESE. Figure (5) revealed that 97% found the software very simple. On the other hand, 73% stated that the database was very confusing.

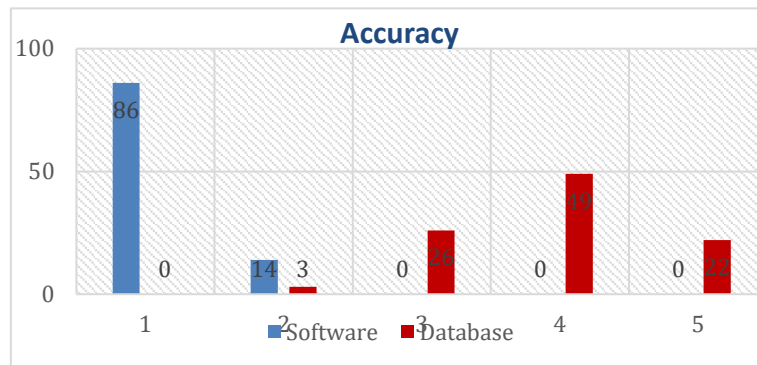

Fig. 6. A comparison between the Accuracy of ESS and ESD

Figure (6) measures the accuracy of the quantity survey calculations for ESE, the calculations of 71% of the participants using ESD were wrong, while 86% of the participant’s calculations using ESS were perfect and 14% had minor errors.

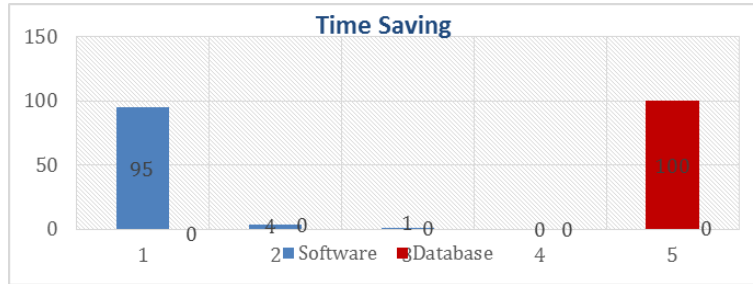

Fig. 7. A comparison between the time spend in using ESS and ESD

ESS provided the users with the ability to design ESE in little time. On the other hand, while using ESD the participants wasted more than an hour to calculate the properties of ESE as shown in figure (7).

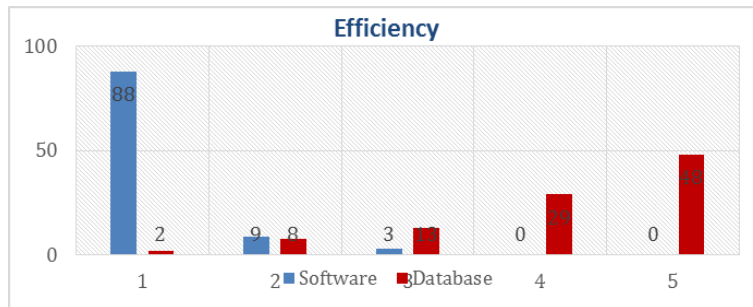

Fig. 8. A comparison between the efficiency in using ESS and ESD

Figure (8) revealed that 97% of the participants using ESS has been able to choose ESE with low cost and high energy production while 77% failed to choose and design the most suitable ESE to the site, which proved the efficiency of ESS.

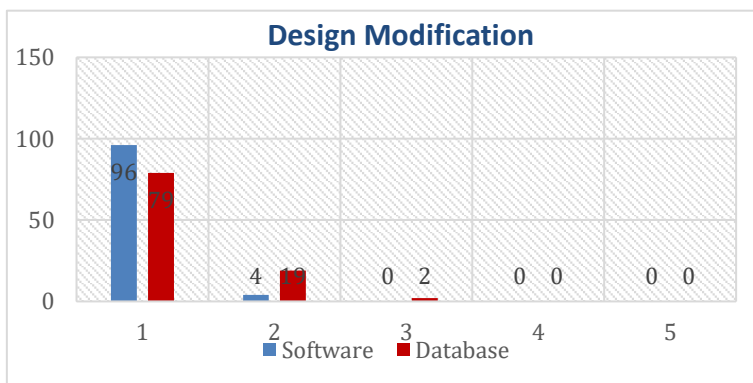

Fig. 9. A comparison between the applicability in modifying the design using ESS and ESD

Design Modification: is the flexibility to change or modify the calculations of the chosen elements with less errors, 100% of ESS users have been able to modify their designs. Moreover, 98% of ESD were able to modify or change the chosen ESE in a flexible way as shown in figure (9).

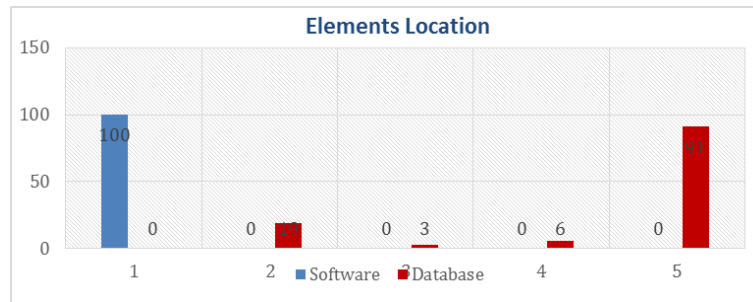

Fig. 10. Evaluating the efficiency of Energy-scape software on suggesting of ESE locations

Elements Location, represents the ability that the design tools give to the participants to choose the most suitable location for the chosen ESE. Figure (10) revealed that 100% of ESS users were able to allocate the places of ESE in their designs even those with weak background toward renewables while 91% of ESD users faced some difficulties for locating ESE.

The participants show positive response toward ESS, while a negative respond toward the database. All the participants agreed that the database was very confusing and not understandable, while the software was very efficient and easy tool to use even for those who didn't have a strong background on renewables as shown in figures (5;6;7;8;9 and 10).

4 Conclusion

The research revealed that Egyptian architects and landscape designers have been able to overcome their weak knowledge toward the use of renewables, using Energy-scape software (ESS). ESS has been proved as a useful landscape designing tool that integrated renewables with landscape elements and helps architects to overcome their basic knowledge of using renewables in their designs. Moreover, the research revealed that without ESS the use of ESE will not be implemented due to the difficulties of using ESD. Egyptian architects and landscape designers found many difficulties in using ESD but this all difficulties has been solved because of ESS.. Energy-scape software is a tool for cleaner energy production, it will provide a useful tool for designers to implement renewables in outdoor spaces which will increase the share of renewables toward energy generation and it will help in producing sustainable cities and cleaner environment. ESS will help in spreading the use of clean and efficient energy generation tool and will help in creating clean and health environment in developing countries such as Egypt.

5 References

- [1] Moussa, R.R., 2019. The Reasons For Not Implementing Green Pyramid Rating System In Egyptian Buildings. *Ain Shams Engineering Journal*, 10(4); 917-927. <https://doi.org/10.1016/j.asej.2019.08.003>
- [2] Moussa, R.R., 2018. The role of energy-scape elements in creating sustainable economic project in Egyptian parks. *Ain Shams Engineering Journal*, 9(4); 3045-3053. <https://doi.org/10.1016/j.asej.2018.09.001>
- [3] Moussa, R.R., and Mahmoud, A.H., 2017. Energy-scape Elements: An Approach on Integrating Landscape Elements with Renewable Energy Devices. *Journal of Cleaner Production*, 153; 114-130. <https://doi.org/10.1016/j.jclepro.2017.03.077>
- [4] Saelens, B.E., Frank, L.D., Auffrey, C., Whitaker, R.C., Burdette, H.L. and Colabianchi, N., 2006. Measuring Physical Environments of Parks and Playgrounds: EAPRS Instrument Development and Inter-Rater Reliability. *Journal of Physical Activity and Health* 3(1): 190-207. <https://doi.org/10.1123/jpah.3.s1.s190>
- [5] Kost, C., Mayer, J., Thomsen, J., Hartmann, N., Senkpie, C., Philipps, L., Schlegl, T., 2013. Levelized Cost of Electricity Renewable Energy Technologies. Fraunhofer Institut for Solar Energy Systems ise. Germany. Available at: https://www.ise.fraunhofer.de/content/dam/ise/en/documents/publications/studies/Fraunhofer-ISE_LCOE_Renewable_Energy_technologies.pdf. <https://doi.org/10.15764/resd.2014.01002>
- [6] Sharaf, O.Z., Orhan, M.F., 2015. Concentrated photovoltaic thermal (CPVT) solar collector systems: Part II – Implemented systems, performance assessment, and future directions. *Renewable and Sustainable Energy Reviews* 50, 1500–1565. <https://doi.org/10.1016/j.rser.2014.07.215>
- [7] Singh, J., 2015. Overview of electric power potential of surplus agricultural biomass from economic, social, environmental and technical perspective—A case study of Punjab. *Renewable and Sustainable Energy Reviews* 42, 286–297. <https://doi.org/10.1016/j.rser.2014.10.015>
- [8] Andrews, R., 2015. A review of concentrated solar power (CSP) in Spain. *Energy, Environment and Policy*. Available at: <http://euanmearns.com/a-review-of-concentrated-solar-power-csp-in-spain/> [Last accessed: 10/10/2016]. <https://doi.org/10.1016/j.enpol.2015.06.028>
- [9] Balaman, S.Y., Selim, H., 2016. Sustainable design of renewable energy supply chains integrated with district heating systems: A fuzzy optimization approach. *Journal of Cleaner Production* 133, 863–885. <https://doi.org/10.1016/j.jclepro.2016.06.001>
- [10] Mao, G., Wang, S., Teng, Q., Zuo, J., Tan, X., Wang, H., Liu, Z., 2017. The sustainable future of hydropower: A critical analysis of cooling units via the Theory of Inventive Problem Solving and Life Cycle Assessment methods. *Journal of Cleaner Production* 142, 2446–2453. <https://doi.org/10.1016/j.jclepro.2016.11.031>
- [11] Quej, V.H., Almorox, J., Ibrakhimov, M., Saito, L., 2017. Estimating daily global solar radiation by day of the year in six cities located in the Yucatán Peninsula, Mexico. *Journal of Cleaner Production* 141, 75–82. <https://doi.org/10.1016/j.jclepro.2016.09.062>
- [12] Moussa, R.R., Dewidar K.M., 2019. Evaluating the Efficiency of Energy-scape software (April 9-12, 2019). 8th International Conference on Software and Information Engineering (ICSIE 2019). Cairo_Egypt. Page 60-65. <https://doi.org/10.1145/3328833.3328868>
- [13] Guirguis, M.N. and Moussa, R.R., 2019. Investigation on utilizing garbage as a resource for a sustainable neighbourhood; Case study of a neighbourhood in New Cairo, (November, 28 -30). (BSCairo2019) Simulation for a Sustainable Built Environment, Cairo_

Egypt. IOP Conf. Series: Earth and Environmental Science 397- 012018. Retrieved from: <https://doi.org/10.1088/1755-1315/397/1/012018>

- [14] Solban, M.M. and Moussa, R.R., 2019. Piezoelectric Tiles Is a Sustainable Approach for Designing Interior Spaces and Creating Self-Sustain Projects. (November, 28 -30). (BSCairo2019) Simulation for a Sustainable Built Environment, Cairo_ Egypt. IOP Conf. Series: Earth and Environmental Science 397- 012020. <https://doi.org/10.1088/1755-1315/397/1/012020>

6 Authors

Dr. Rania Rushdy is a Lecturer in Architecture department, faculty in Engineering_ The British university in Egypt. She has done Research in Architectural Environmental studies. Rania.rushdy@bue.edu.eg

Prof. Khaled Mohamed Dewidar is Vice dean for the faculty of Engineering_ The British university in Egypt. His Research field includes History of Architecture. Khaled.Dewidar@bue.edu.eg

Article submitted 2020-02-09. Resubmitted 2020-03-12. Final acceptance 2020-03-13. Final version published as submitted by the authors.